

Cameras

D.A. Forsyth, UIUC

Cameras

- First photograph due to Niepce
- First on record shown in the book - 1822
- Basic abstraction is the pinhole camera
 - lenses required to ensure image is not too dark
 - various other abstractions can be applied

Pinhole cameras

- Abstract camera model - box with a small hole in it
- Pinhole cameras work in practice

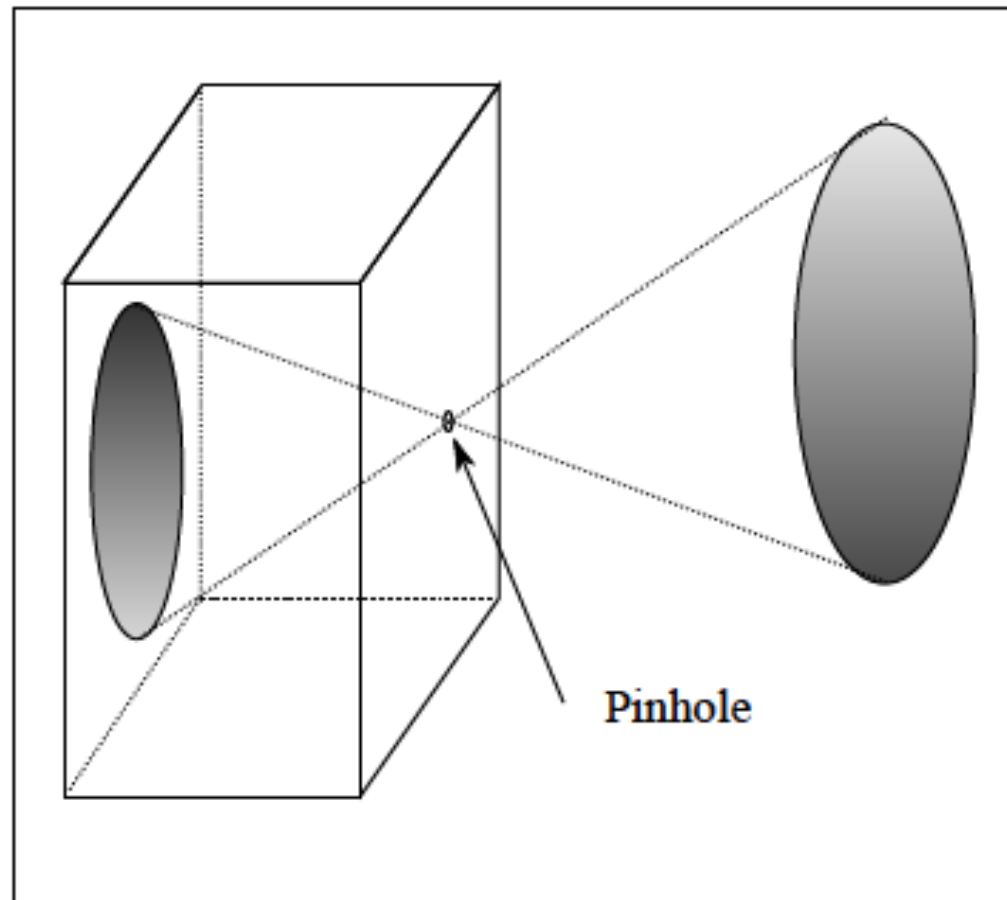

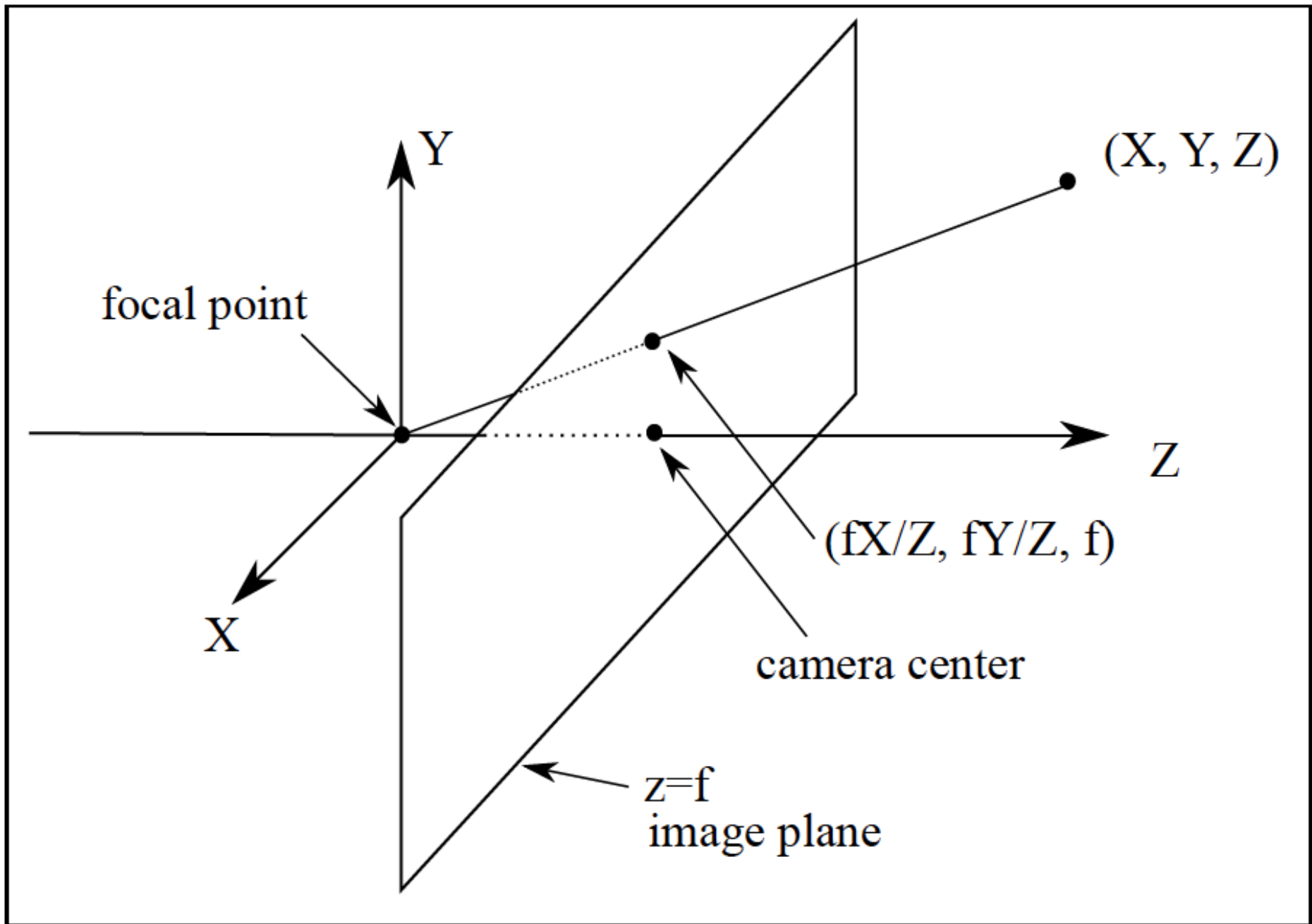

Perspective effects

2.1.2 Perspective Effects

Perspective projection has a number of important properties, summarized as:

- lines project to lines;
- more distant objects are smaller;
- lines that are parallel in 3D meet in the image;
- planes have horizons;
- planes image as half-planes.

Lines->lines; distant objects smaller

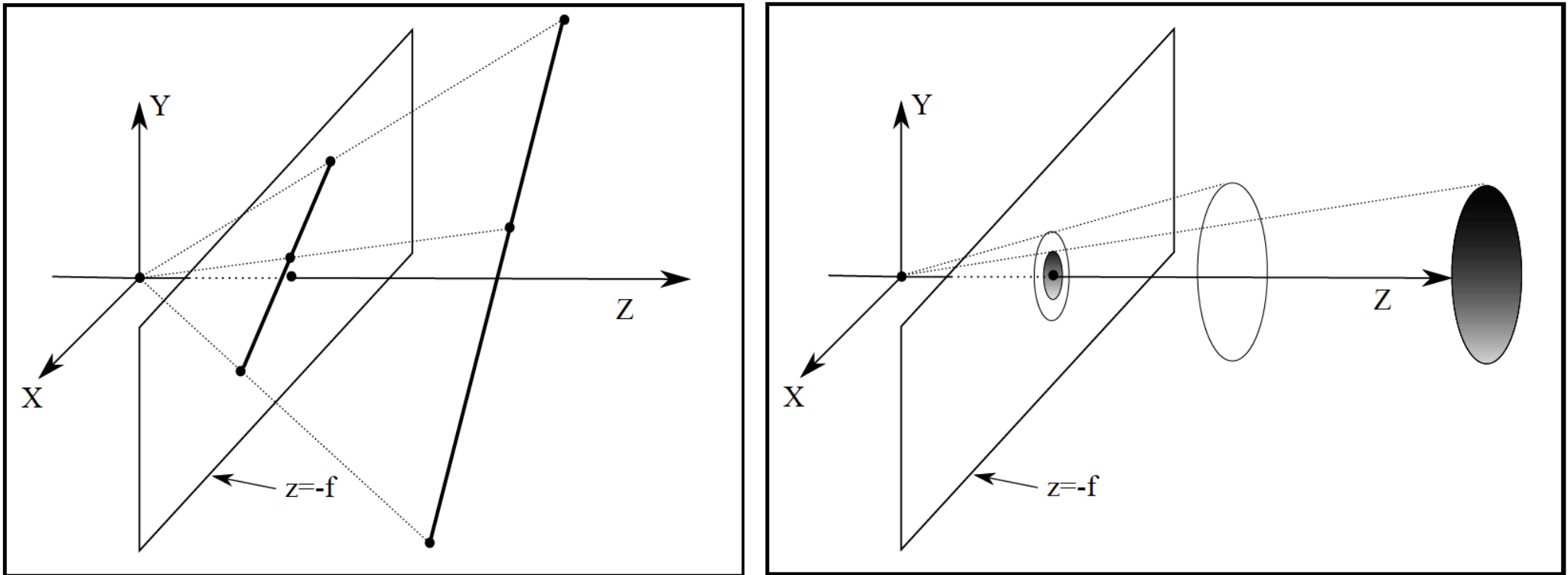
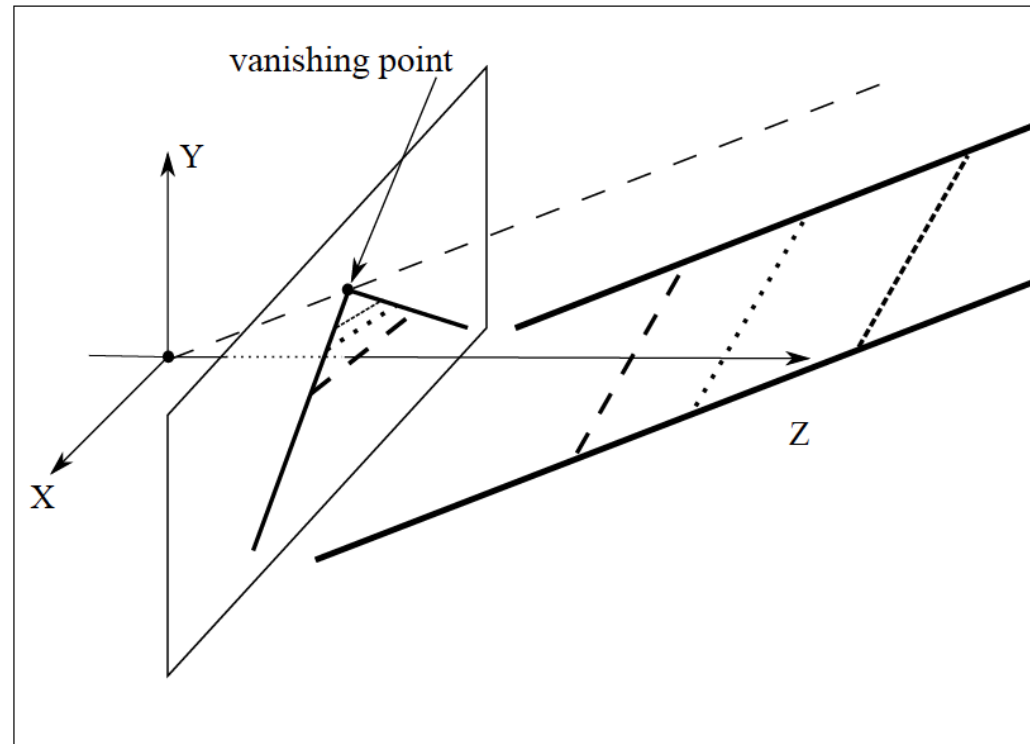
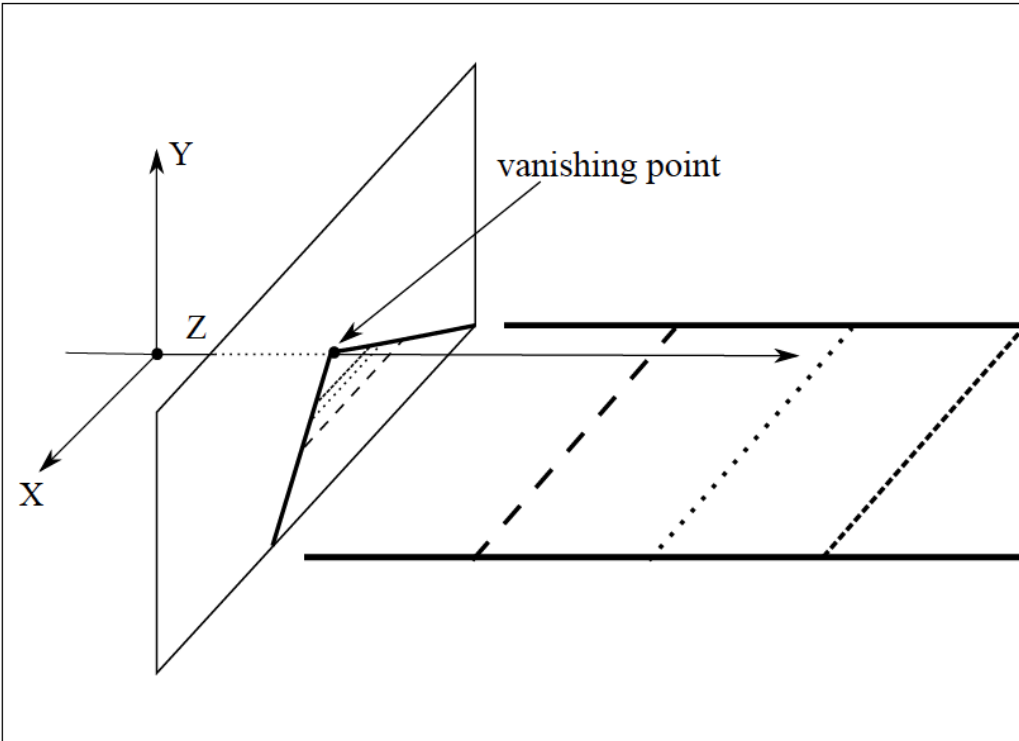

FIGURE 2.2: *Perspective projection maps almost any 3D line to a line in the image plane (left). Some rays from the focal point to points on the line are shown as dotted lines. The family of all such rays is a plane, and that plane must intersect the image plane in a line as long as the 3D line does not pass through the focal point. On the right, two 3D objects viewed in perspective projection; the more distant object appears smaller in the image.*

Parallel lines meet



Vanishing points

- Each set of parallel lines (=direction) meets at a different point
 - The vanishing point for this direction
- Good ways to spot faked images
 - scale and perspective don't work
 - vanishing points behave badly
 - supermarket tabloids are a great source.

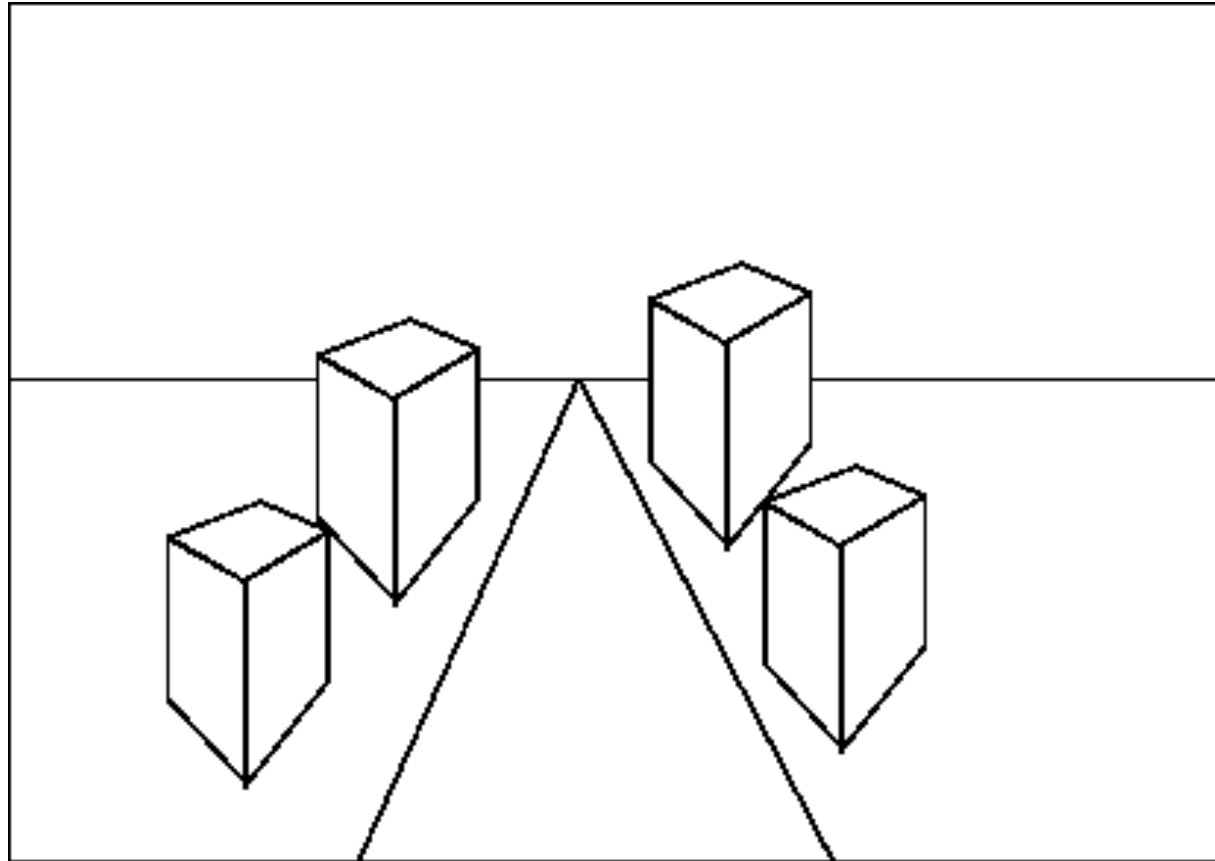

Planes have horizons

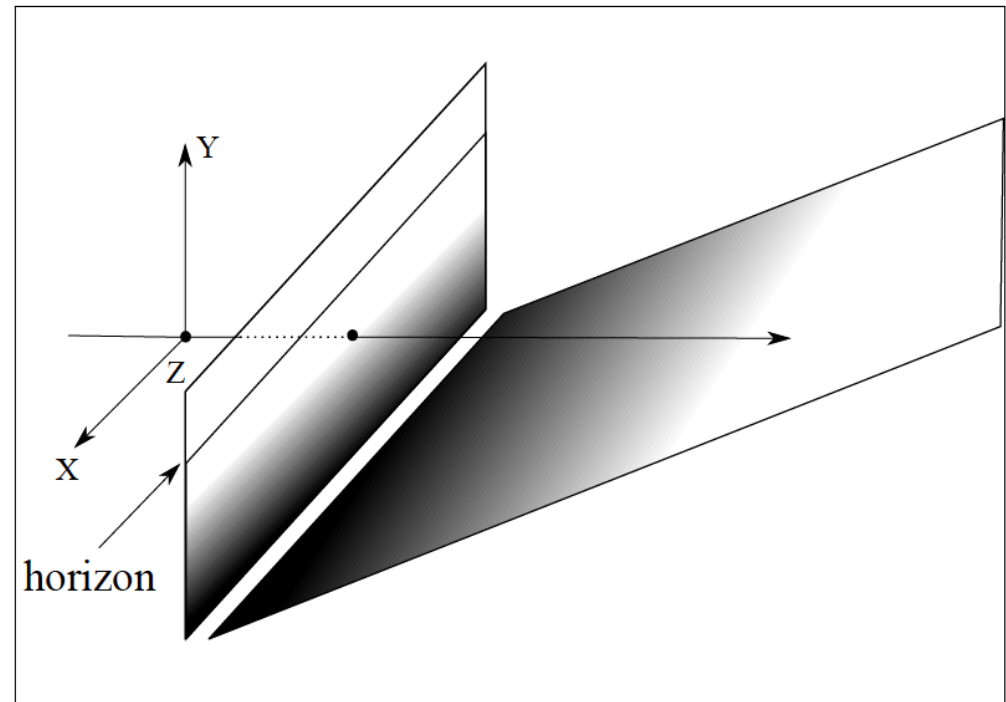
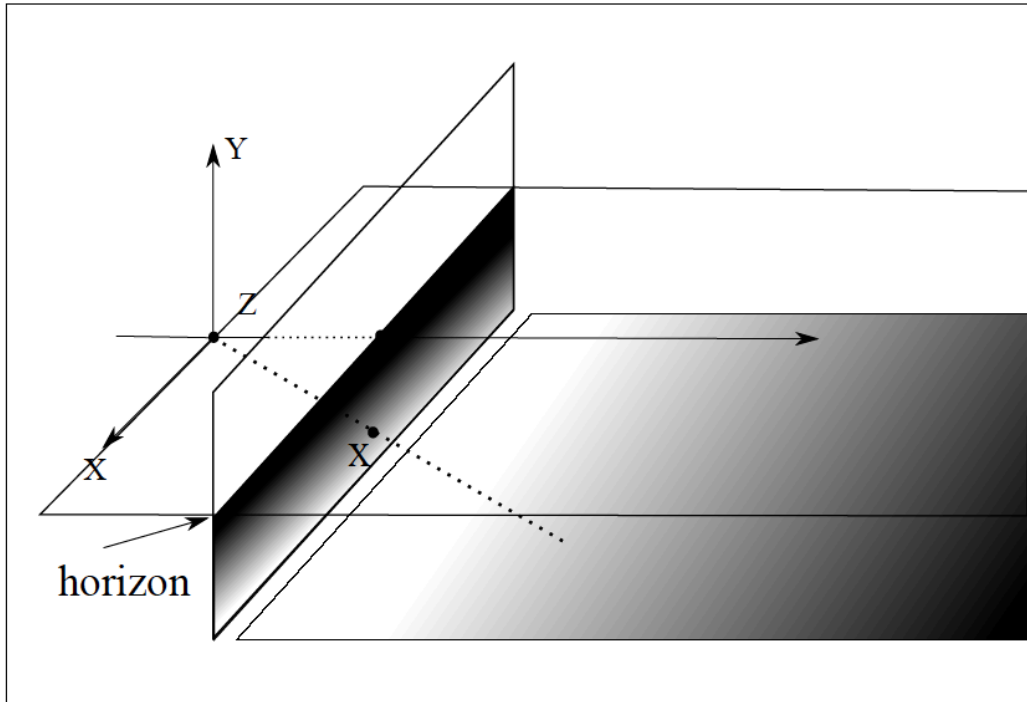

The equation of projection - I

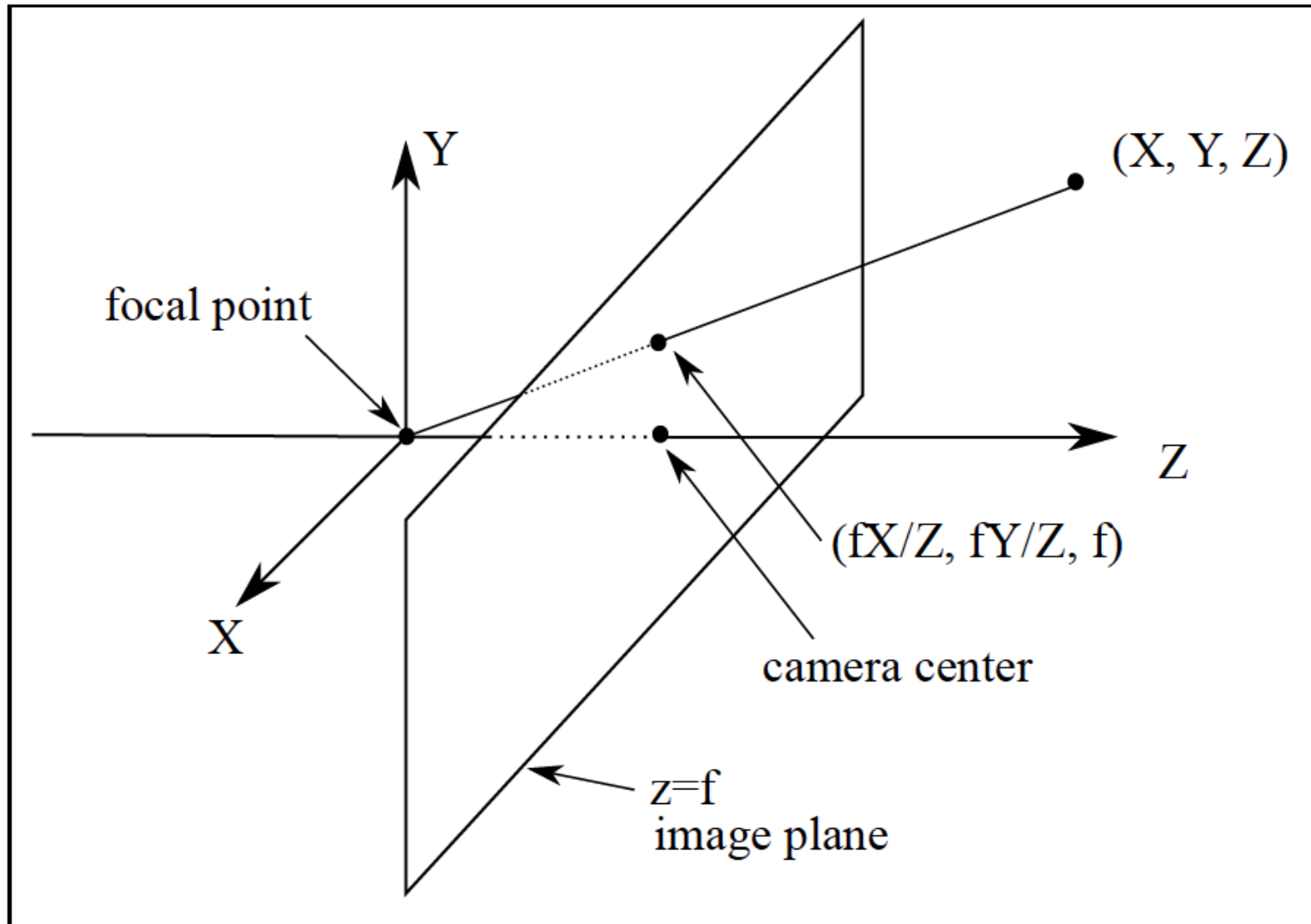

The equation of projection - II

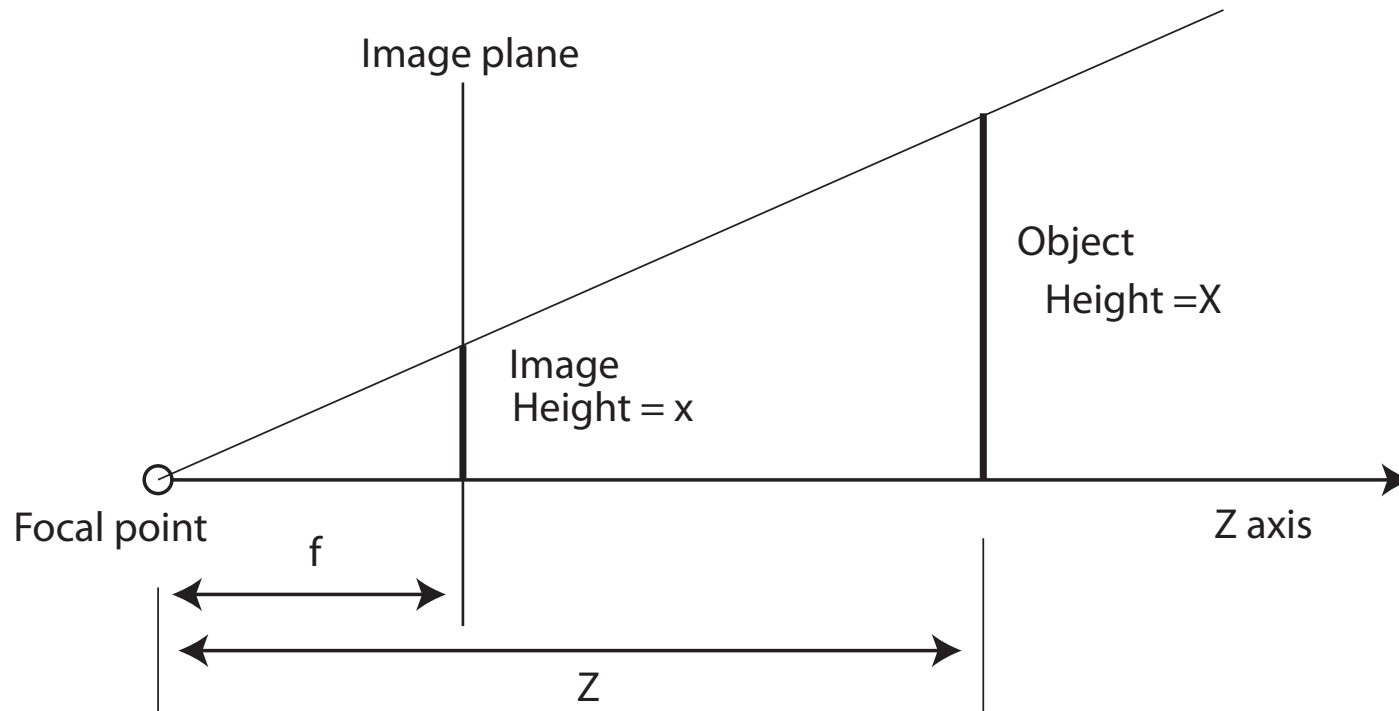

The equation of projection - III

- Cartesian coordinates:

- We have, by similar triangles, that $(X, Y, Z) \rightarrow (f X/Z, f Y/Z, f)$

- Ignore the third coordinate, and get

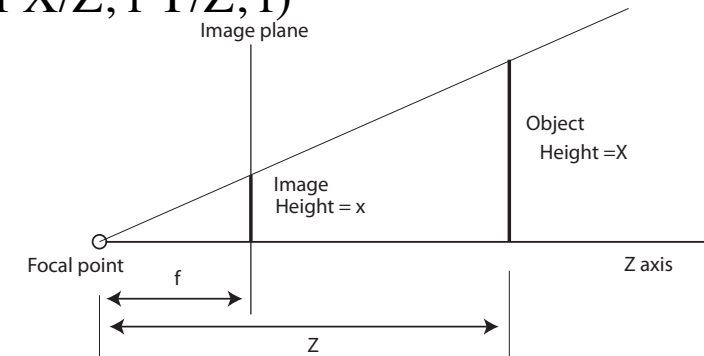

$$(X, Y, Z) \rightarrow (f X/Z, f Y/Z)$$

- notice we could have sign changes, etc. depending on
 - whether there is a right handed/left handed coordinate system
 - whether image plane is in front of/behind focal point

Remember this: *Most practical cameras can be modelled as a pinhole camera. A pinhole camera with focal length f maps*

$$(X, Y, Z) \rightarrow (fX/Z, fY/Z).$$

Figure 2.1 shows important terminology (focal point; image plane; camera center).

Scaled orthographic projection

- Assume
 - The range of depths over points is small compared to distance to points

$$Z_i = Z_0 + \delta Z_i$$

$$\frac{1}{Z_i} = \frac{1}{Z_0} \left(\frac{1}{1 + \frac{\delta Z_i}{Z_0}} \right) \approx \frac{1}{Z_0} \left(1 - \frac{\delta Z_i}{Z_0} \right) \approx \frac{1}{Z_0}$$

- So you could scale all points with one scale
 - Scaled orthography

Scaled orthographic projection - II

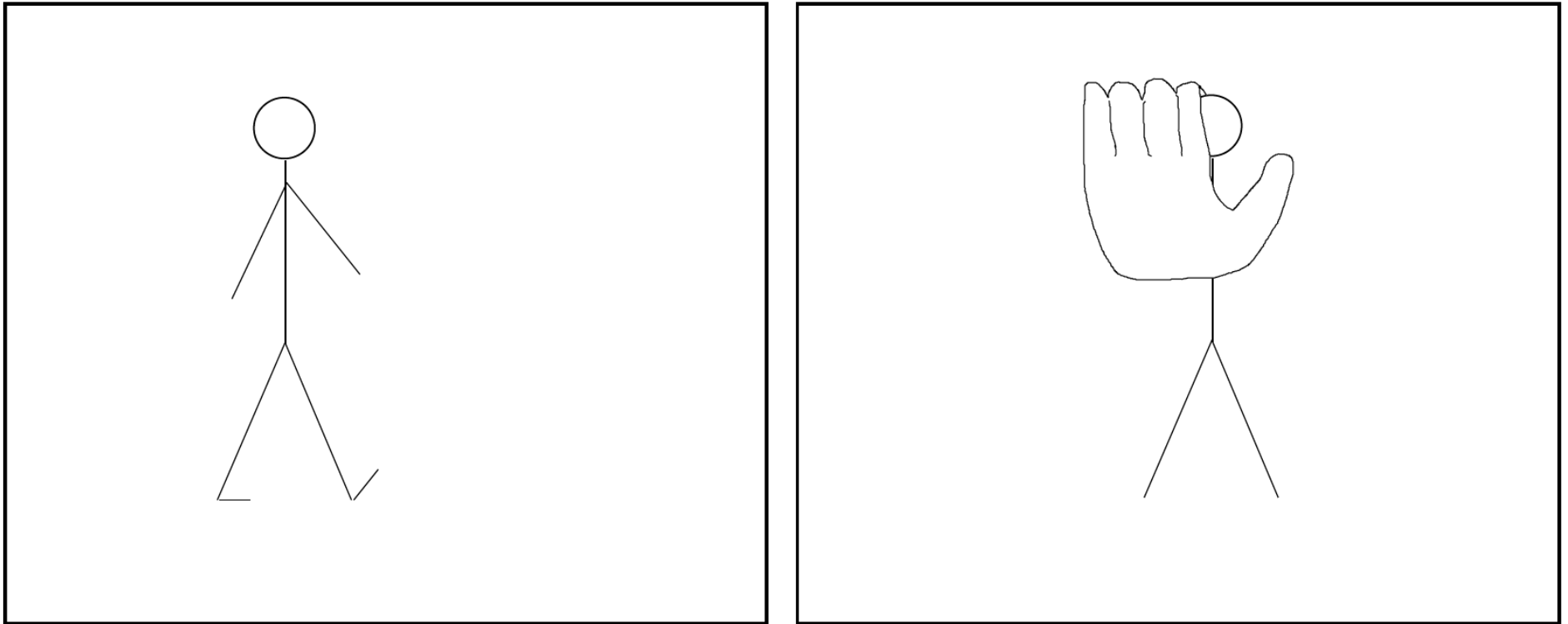

FIGURE 2.5: *The pedestrian on the **left** is viewed from some way away, so the distance to the pedestrian is much larger than the change in depth over the pedestrian. In this case, which is quite common for views of people, scaled orthography will apply. The celebrity on the **right** is holding a hand up to prevent the camera viewing their face; the hand is quite close to the camera, and the body is an armslength away. In this case, perspective effects are strong. The hand looks big because it is close, and the head looks small because it is far.*

Remember this: *Scaled orthographic projection maps*

$$(X, Y, Z) \rightarrow s(X, Y)$$

where s is some scale. The model applies when the distance to the points being viewed is much greater than their relief. Many views of people have this property.

Lenses

- Pinholes admit very little light
 - and only work because they are small

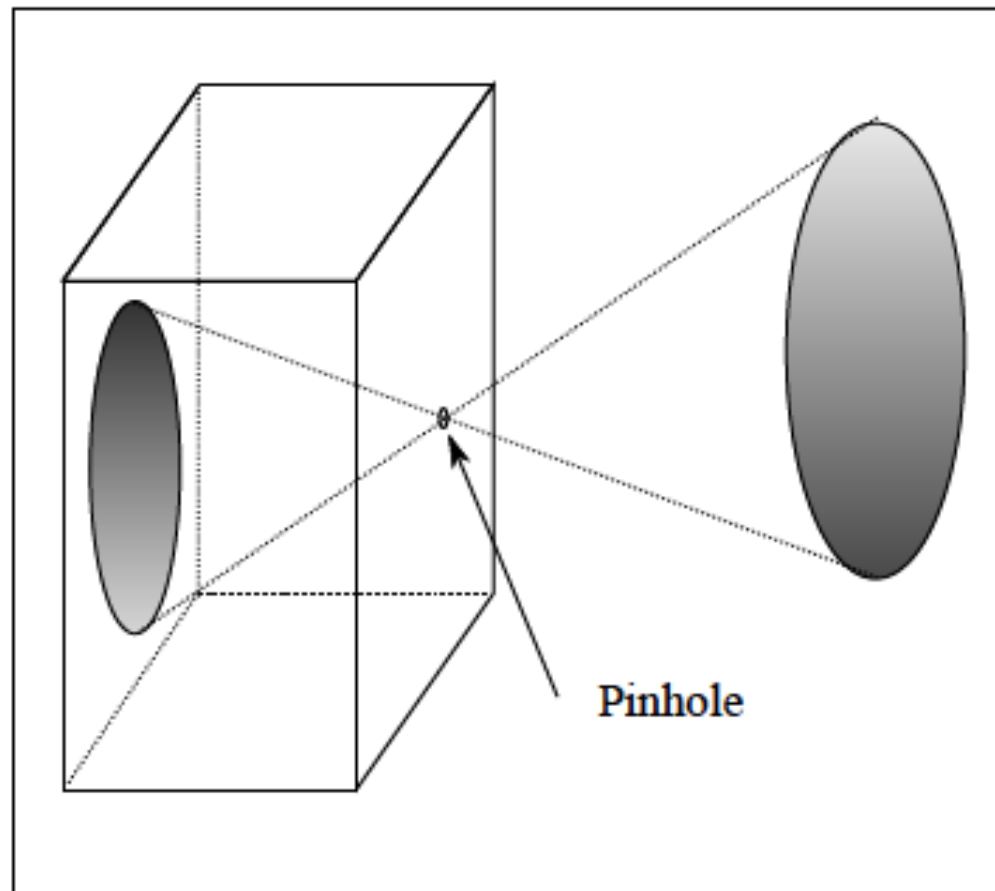

Pinhole too big -
many directions are
averaged, blurring the
image

Pinhole too small -
diffraction effects blur
the image

Generally, pinhole
cameras are *dark*, because
a very small set of rays
from a particular point
hits the screen.

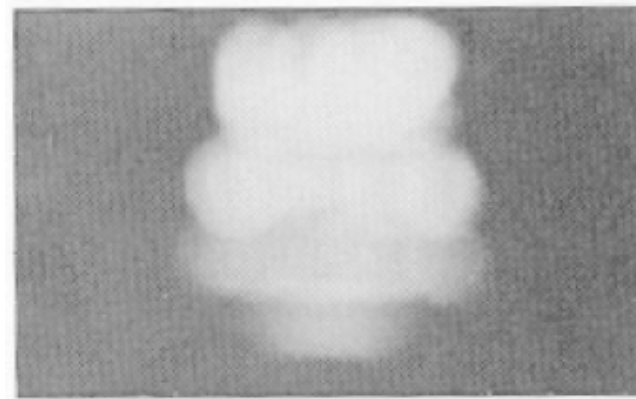

2 mm

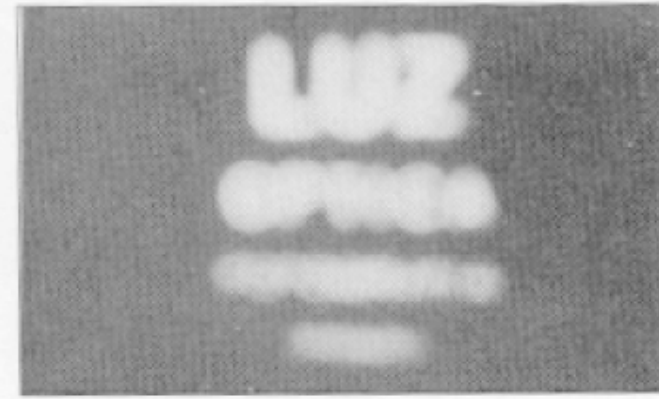

1 mm



0.6mm



0.35 mm



0.15 mm

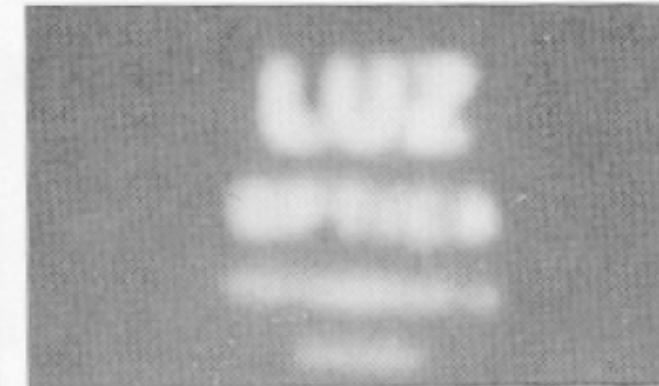

0.07 mm

Lenses

- Pinholes admit very little light
 - and only work because they are small
- Lens system
 - Collect much more light
 - Ensure camera behaves like a pinhole camera
 - roughly!

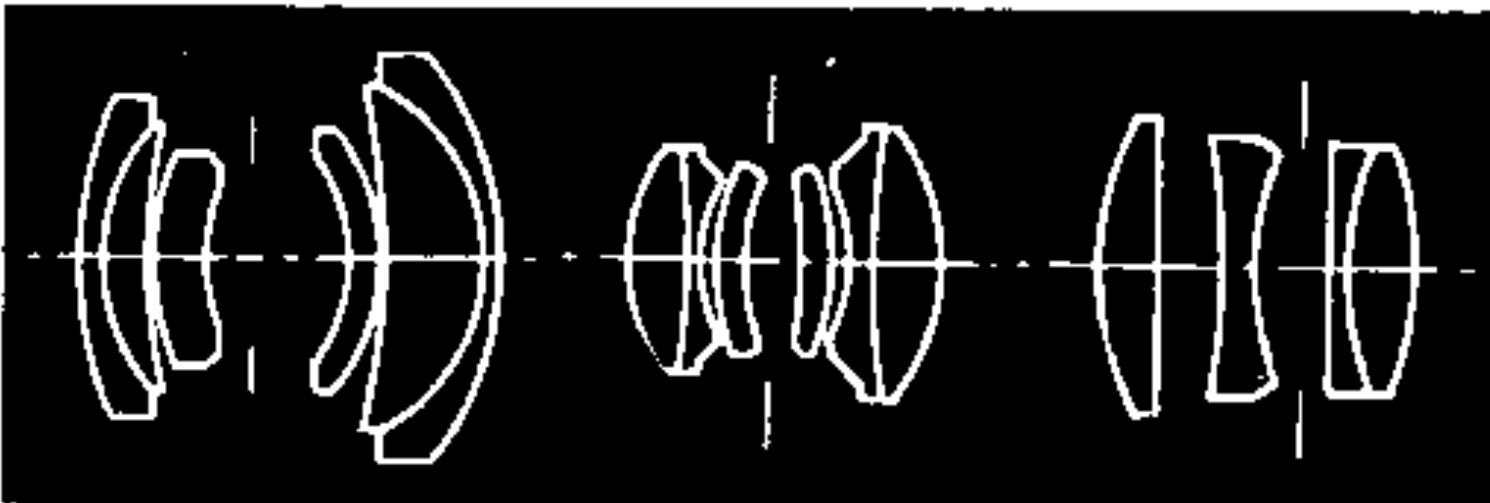
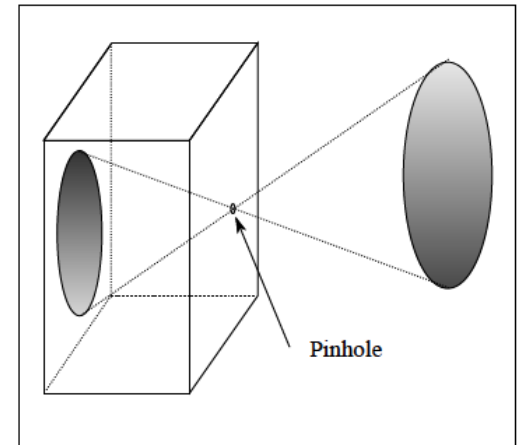

Possibly annoying lens phenomena

- Spherical aberration
 - Lens is not a perfect thin lens, and point is defocused
- Chromatic aberration
 - Light at different wavelengths follows different paths; hence, some wavelengths are defocussed
 - Machines: coat the lens
 - Humans: live with it
- Scattering at the lens surface
 - Light in lens system reflects off surfaces
 - Machines: coat the lens, interior
 - Humans: live with it (scattering phenomena are visible in the human eye)
- Geometric phenomena (Barrel distortion, etc.)

Geometric distortions in lenses

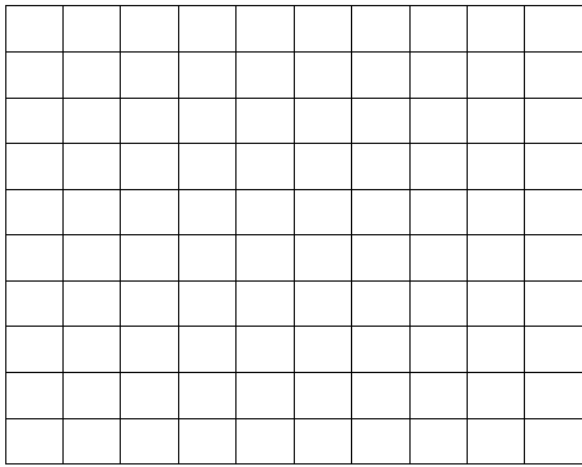

Neutral grid

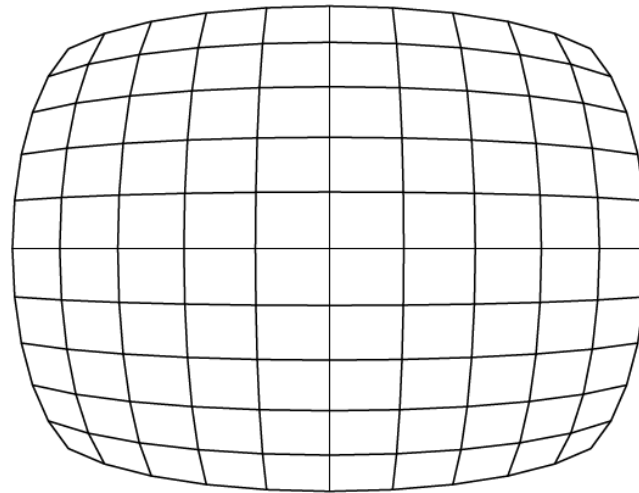

Barrel distortion

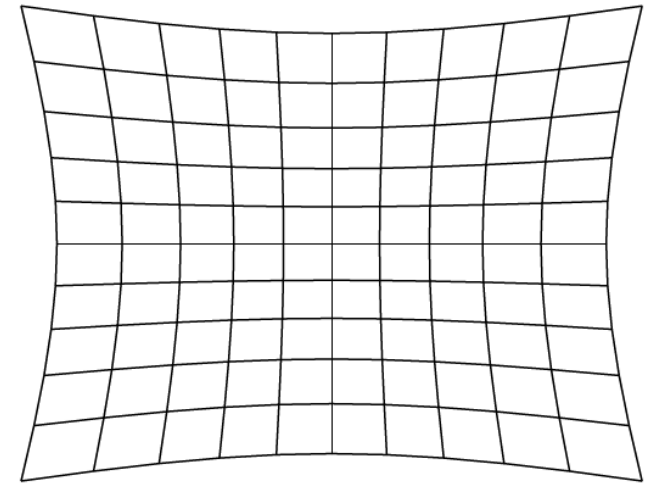

Pincushion distortion

FIGURE 2.6: *On the left a neutral grid observed in a non-distorting lens (and viewed frontally to prevent any perspective distortion). Center shows the same grid, viewed in a lens that produces barrel distortion. Right, the same grid, now viewed in a lens that produces pincushion distortion.*