

Building a working autoencoder – II Examples

D.A. Forsyth

University of Illinois at Urbana Champaign

Example blocks

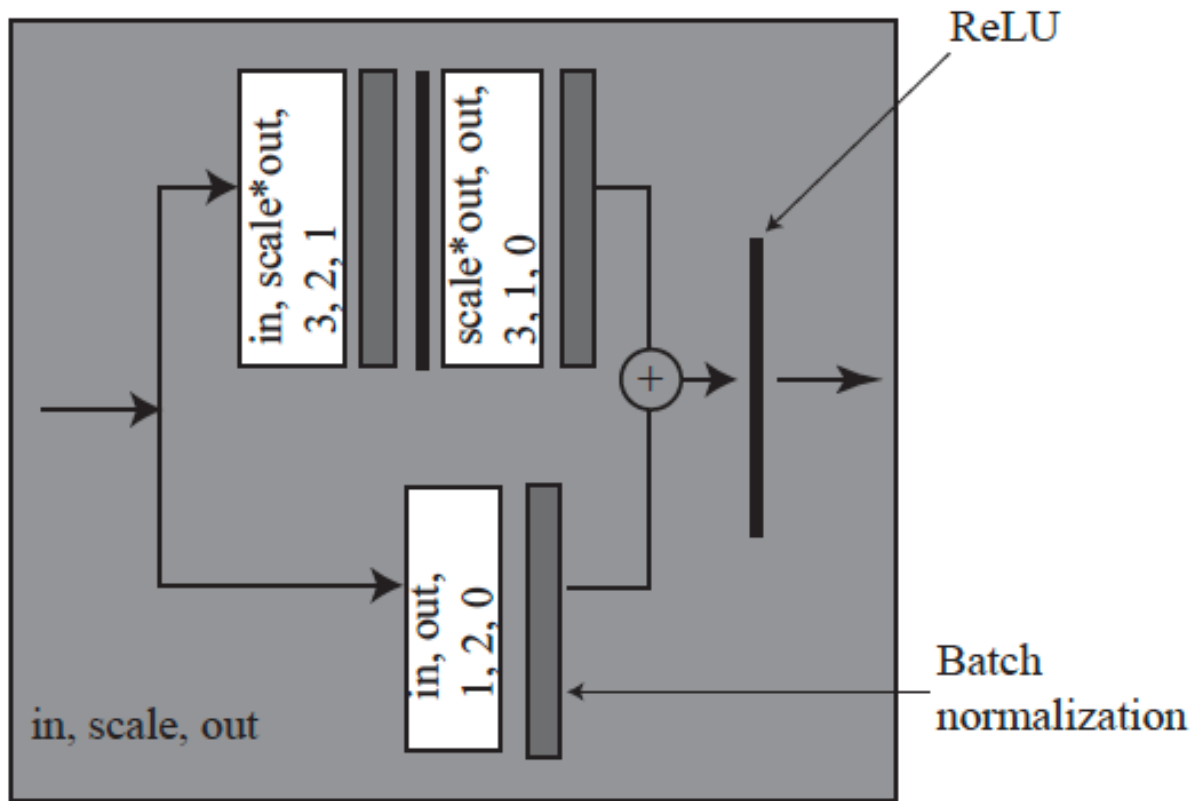

Encoder block

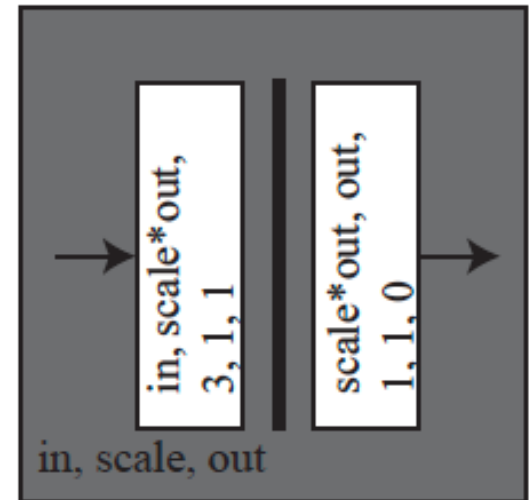

Decoder block

Small autoencoder

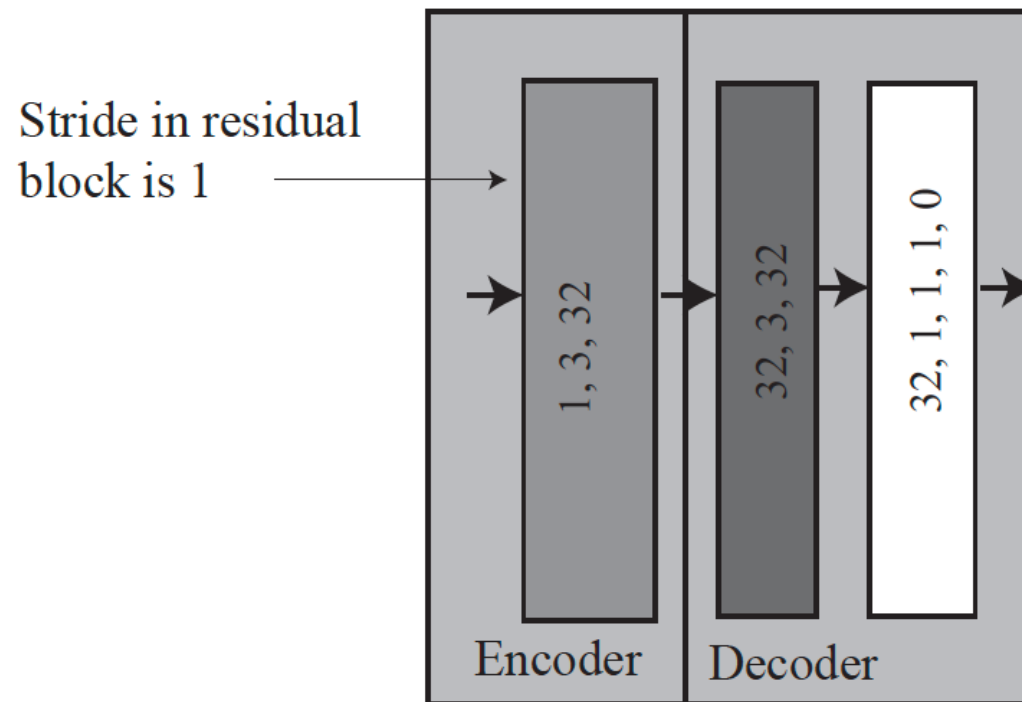

Bigger autoencoder

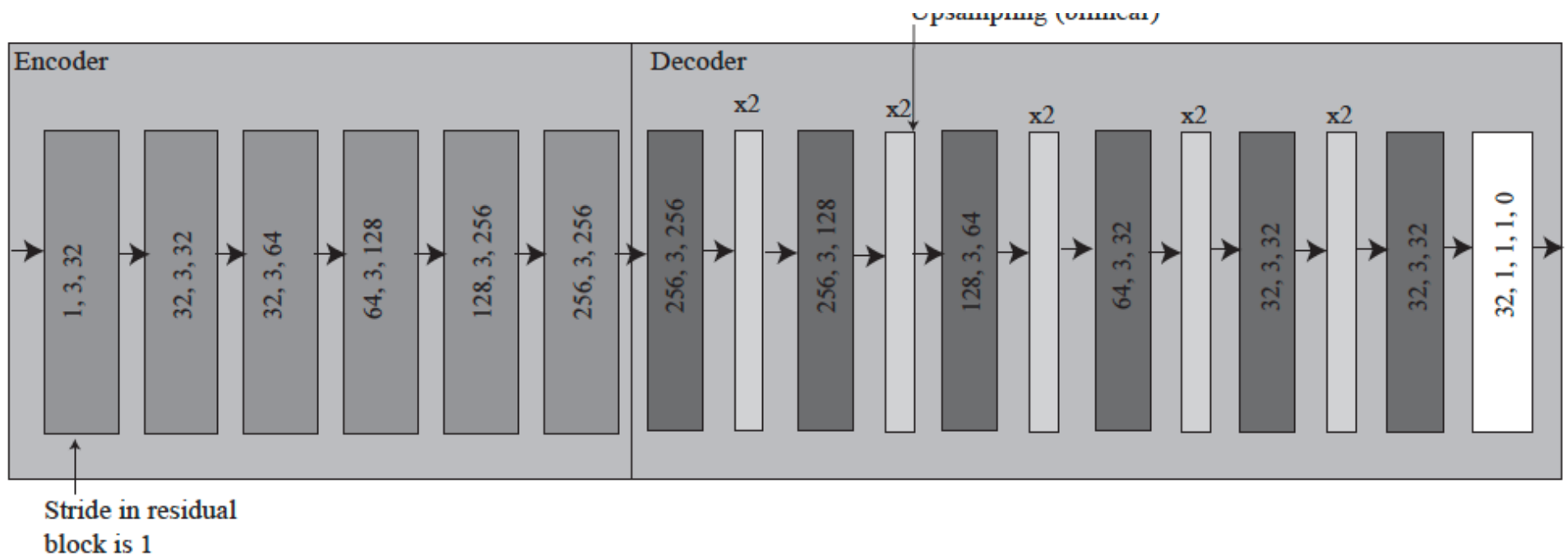

Bigger with skip

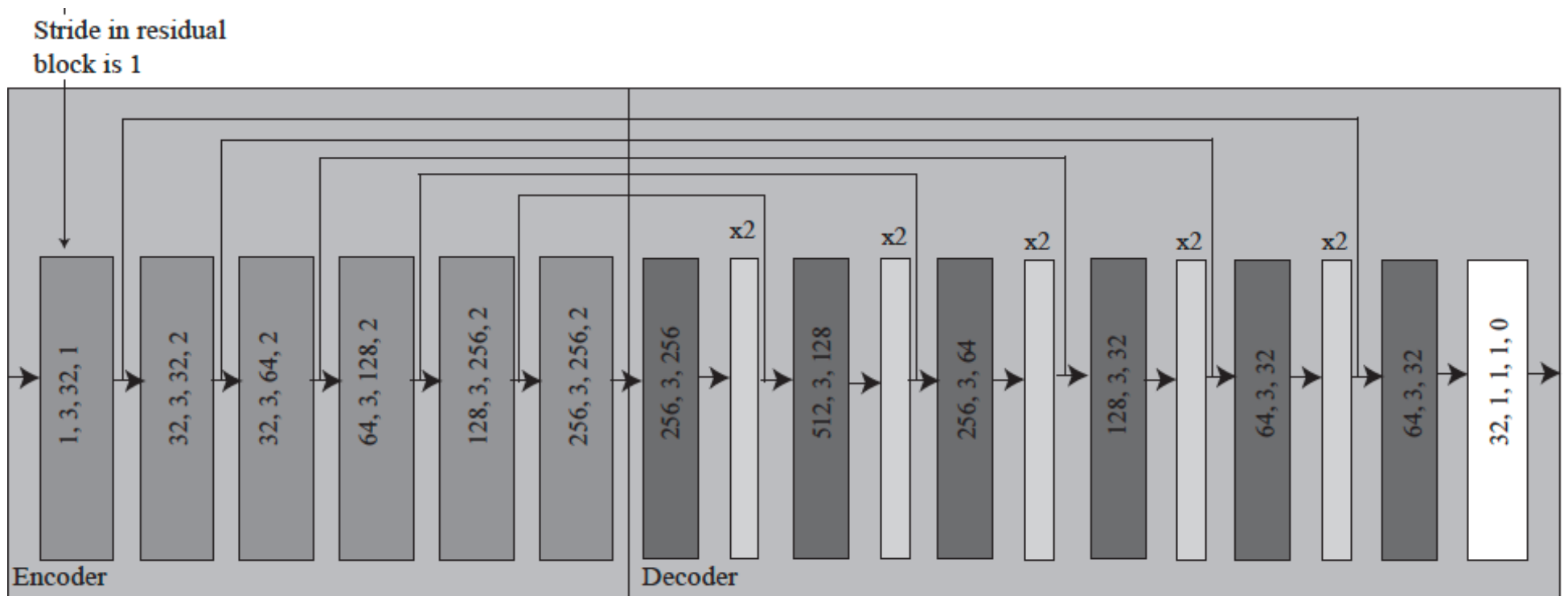

Training

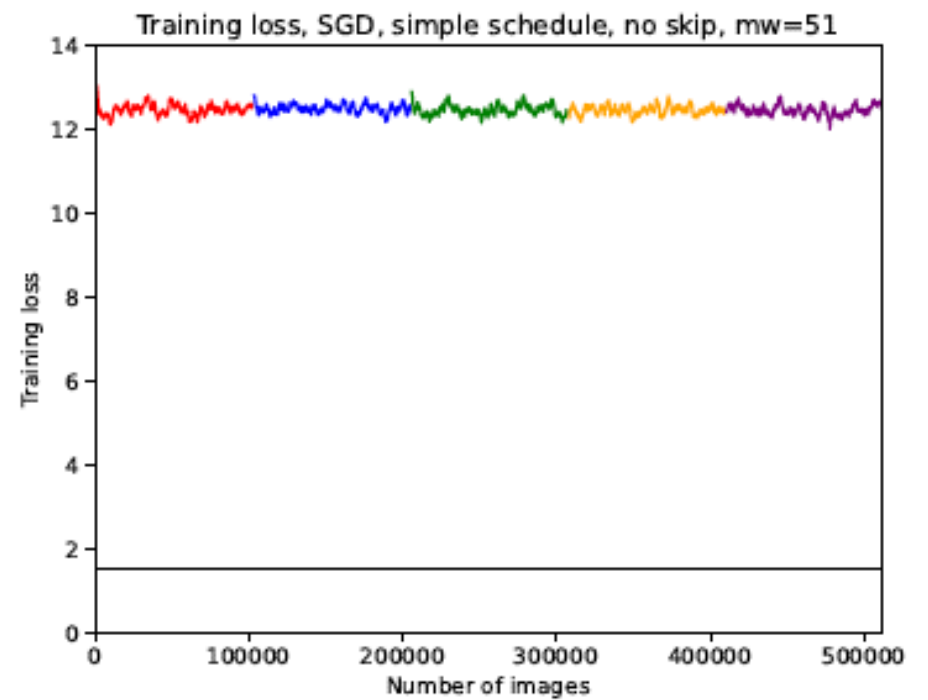
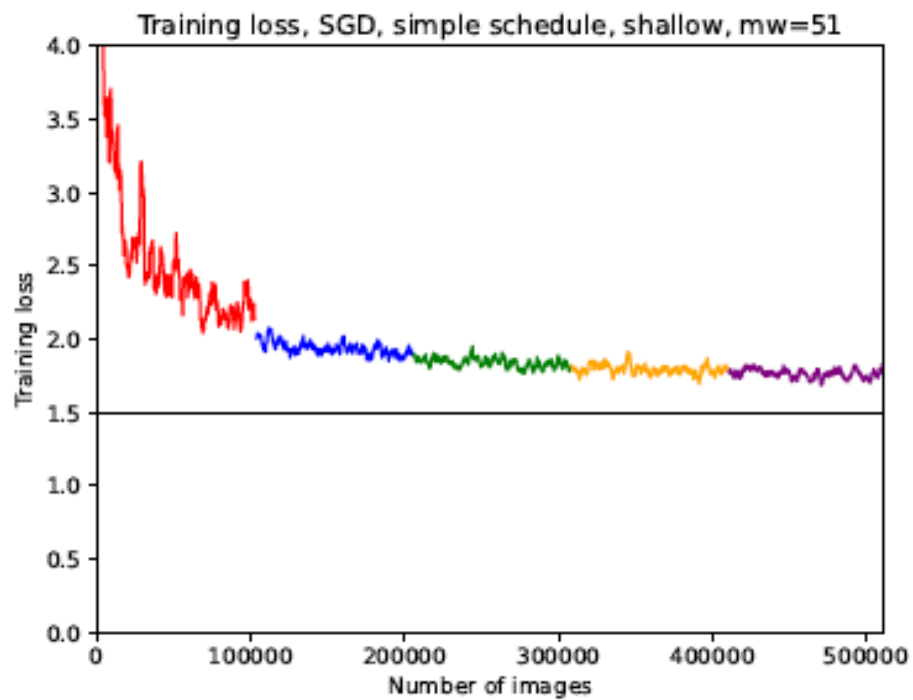

Learning rate schedules help

